

产品名称：功率限幅器

产品型号：HD-15LT38S

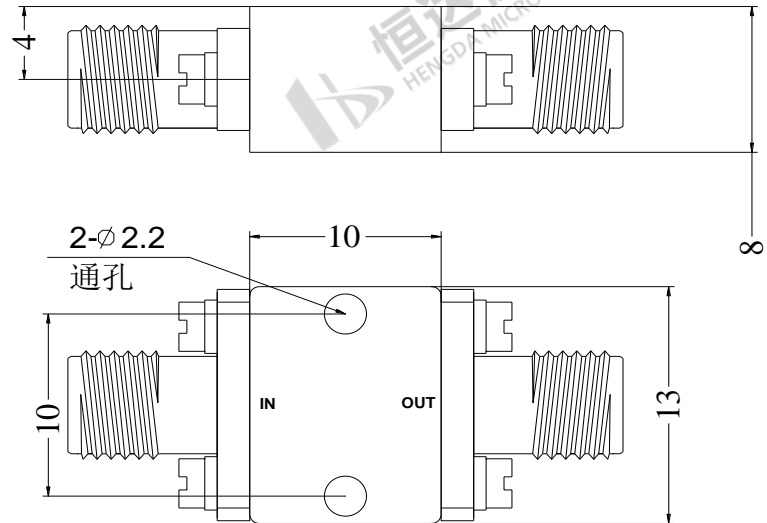
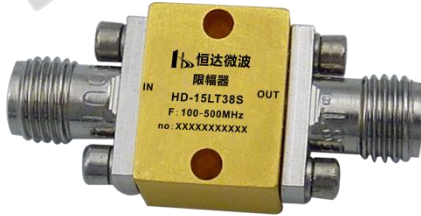

1. 详细技术参数 (*为主要参数)

参 数	最小值	典型值	最大值	单位
频率范围	100		500	MHz
连续波输入功率			5	W
峰值功率 (30us脉宽5%占空比)			15	W
插入损耗		0.3	0.6	dB
驻波比		1.1	1.3	: 1
泄漏值 (输入功率 > 30dBm)		17	20	dBm
峰值功率泄漏		20	25	dBm
重量	9.92			g
输入输出连接头	SMA-Female			
腔体材料	铝			
表面处理	镀金			

2. 额定参数与环境

工作温度	-45° C~+85° C
存储温度	-55° C~+125° C
海拔高度	762米 (环氧树脂密封条件)
	1524米. 最小1个标准大气压(气密封装条件)(可选)

3. 产品测试图

损耗

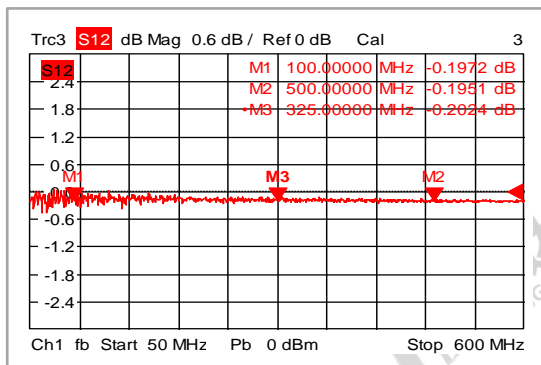

输入驻波比

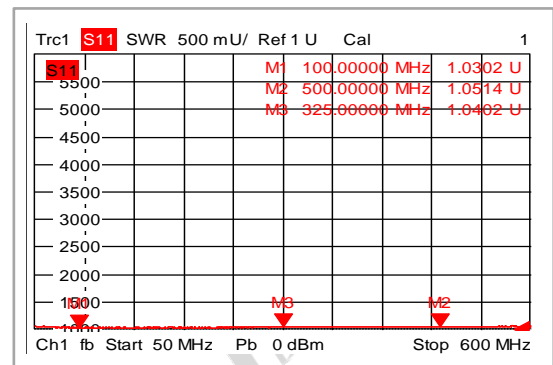

输出驻波比

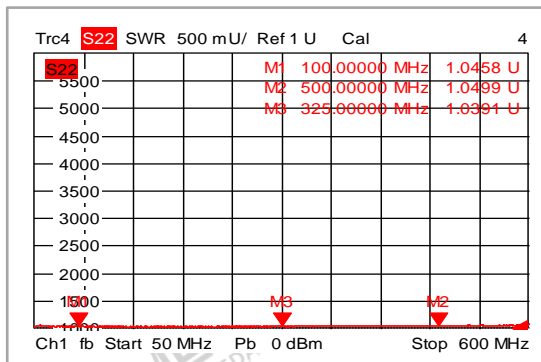

泄露功率

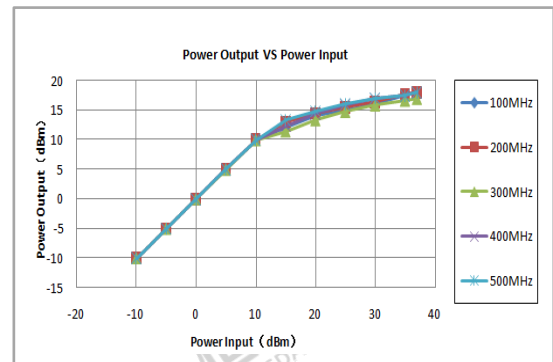

限幅时间

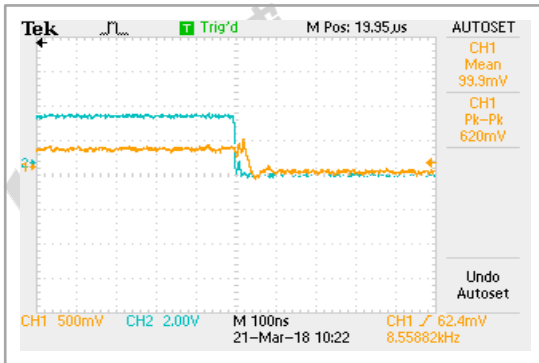

恢复时间

