

产品名称：宽带功率限幅器

产品型号：HD-75125LT47S

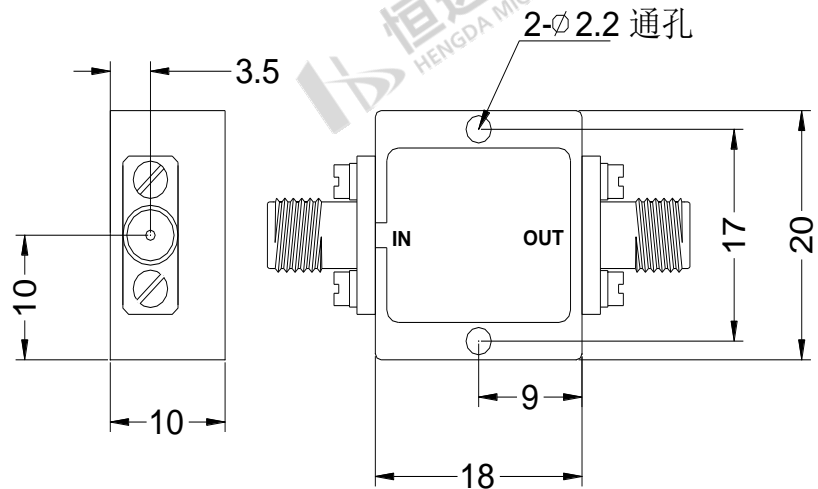

1. 详细技术参数 (*为主要参数)

参 数	最小值	典型值	最大值	单位
频率范围	7.5		12.5	GHz
连续波输入功率 (阻抗50Ω, 温度25℃)			40	dBm
连续波输入功率 (阻抗50Ω, 温度85℃)			36	dBm
峰值功率 (100us脉宽10%占空比, 阻抗50Ω, 温度25℃)			47	dBm
峰值功率 (100us脉宽10%占空比, 阻抗50Ω, 温度85℃)			46	dBm
插入损耗		0.75	1.0	dB
驻波比		1.3	1.5	: 1
泄漏值 (输入功率 > 30dBm)		18		dBm
峰值功率泄漏		20		dBm
重量	30.05			g
输入输出连接头	SMA-Female			
腔体材料	铝			
表面处理	镀金			

2. 额定参数与环境

工作温度	-45° C~+85° C
存储温度	-55° C~+125° C
海拔高度	762米 (环氧树脂密封条件)
	1524米. 最小1个标准大气压(气密封装条件)(可选)

3. 产品测试图

损耗 (+25°C)

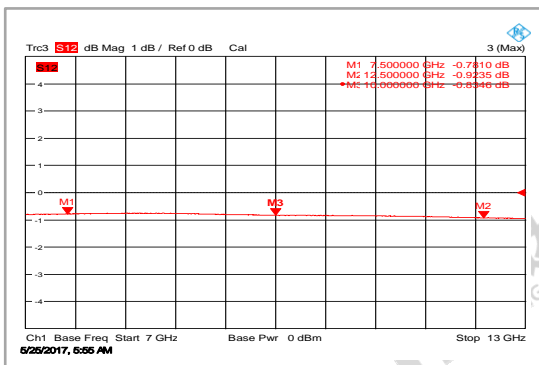

输入驻波比 (+25°C)

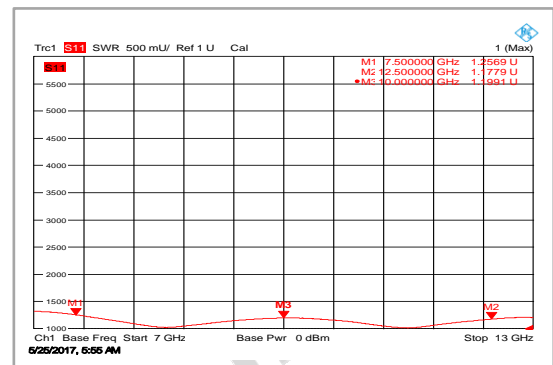

输出驻波比 (+25°C)

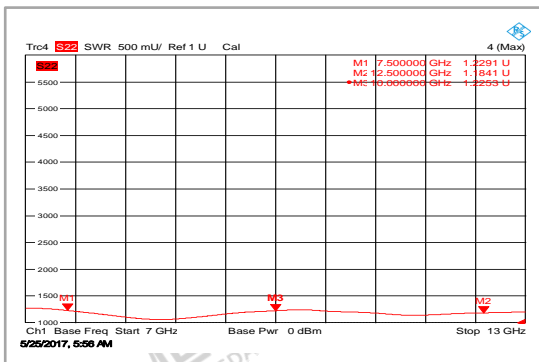

损耗 (-45°C)

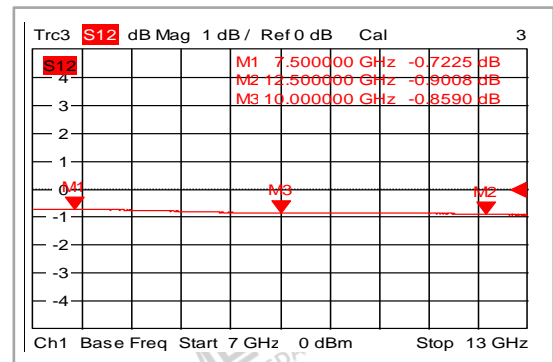

输入驻波比 (-45°C)

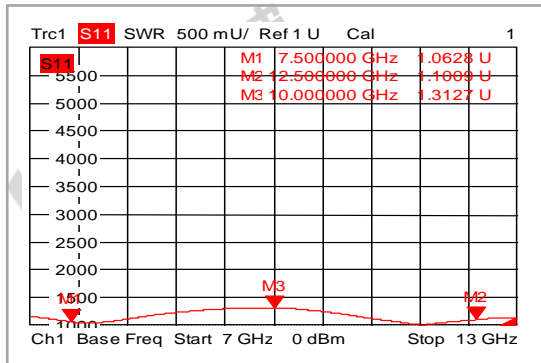

输出驻波比 (-45°C)

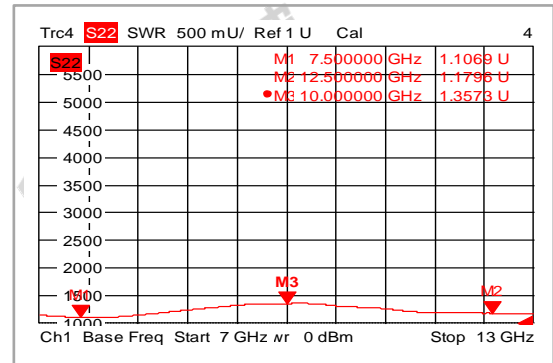

损耗 (+85°C)

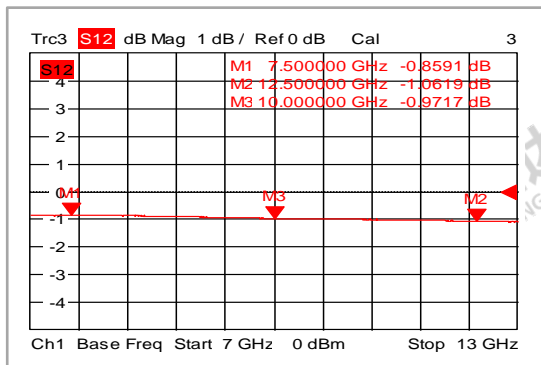

输入驻波比 (+85°C)

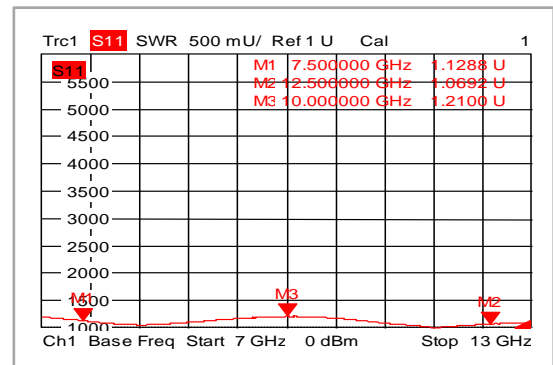

输出驻波比 (+85°C)

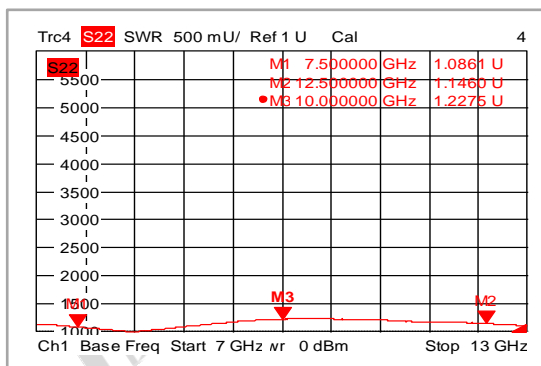

泄露功率

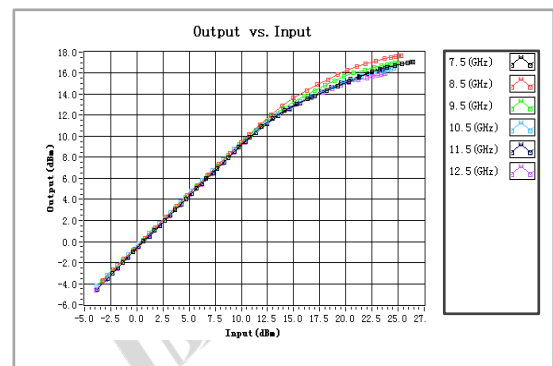

限幅时间

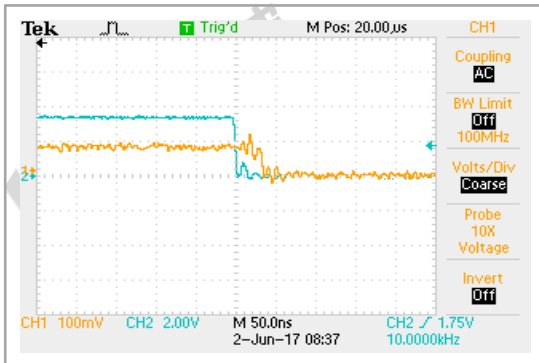

恢复时间

